

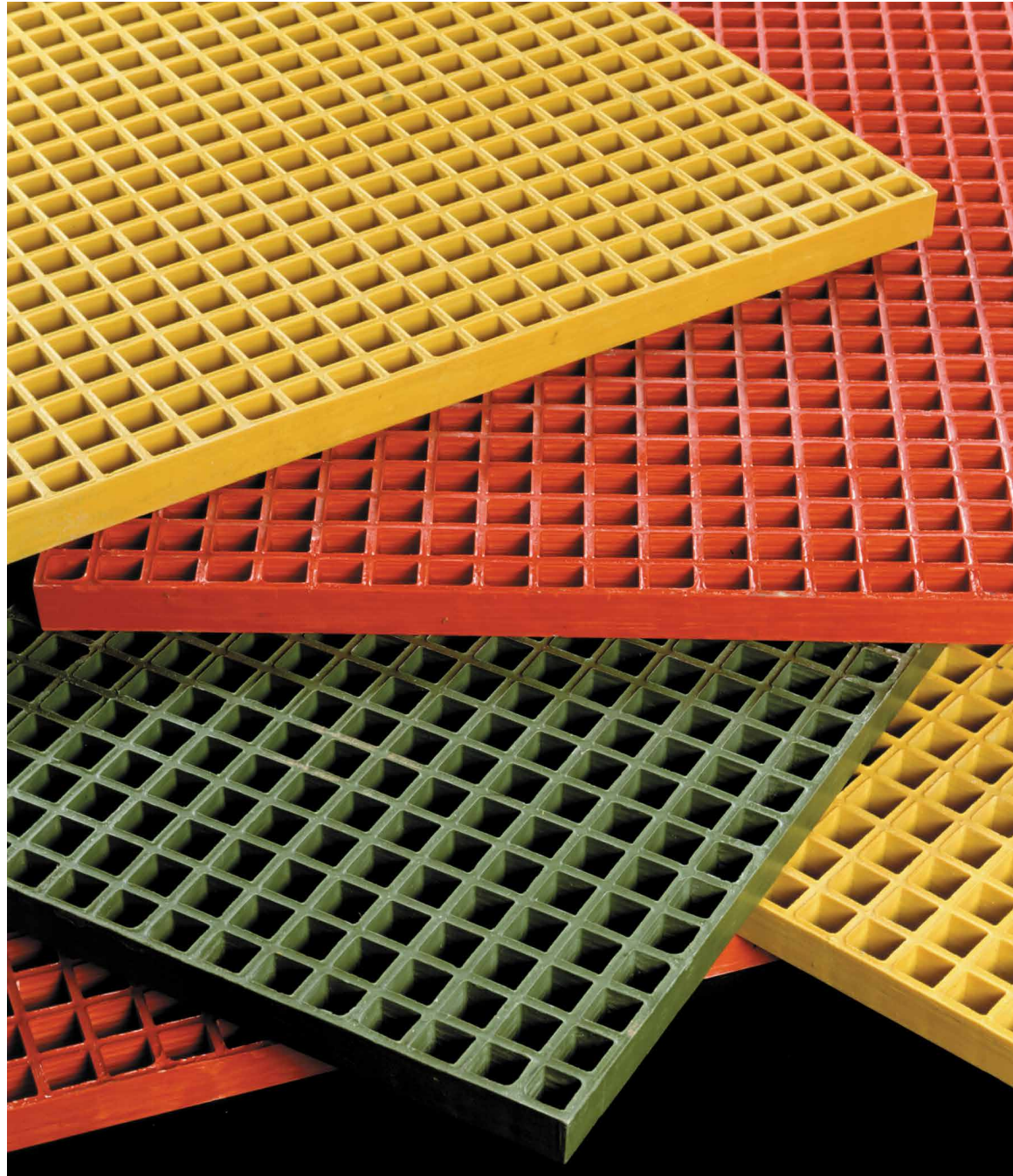

DURA **GRATE**®

MOLDED FIBERGLASS GRATING

Alro Plastics



Molded Fiberglass Grating

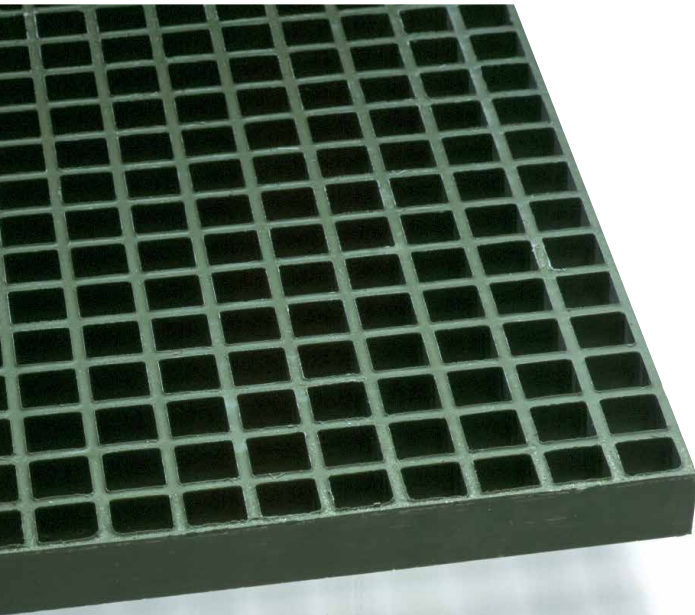

What is DURAGRATE®?

DURAGRATE® molded fiberglass grating is a strong mesh grating panel that is the chemical resistant flooring choice for many industrial applications. DURAGRATE® panels are molded in one piece and feature a concave non-slip walking surface. The cost-effective panels allow for efficient on-site cutting to minimize grating waste and load bearing bars in both directions allow for use without continuous side support.

DURAGRATE® molded fiberglass grating is significantly lighter in weight than metallic gratings and the high resin content provides excellent corrosion resistance and requires very little maintenance. A higher safety factor is achieved by designing in a higher glass content at the bottom of the grating for greater tensile strength.

DURAGRATE® molded fiberglass grating is:

- Corrosion Resistant
- Fire Retardant
- Low in Maintenance
- Lightweight
- Easy To Install
- Uniform in Appearance
- Easy To Fabricate
- Impact Resistant
- Low in Conductivity
- Bidirectional Load Bearing
- Cost Effective

Materials of Construction

DURAGRATE® molded fiberglass grating is composed of fiberglass rovings combined with a choice of five thermosetting resin systems. All of the resins contain a UV inhibitor.

Standard DURAGRATE® grating has a concave profile on the upper surface for skid resistance. Grit tops are available upon request.



The Exide Battery Plant in Manchester, Iowa installed corrosion resistant DURAGRATE® around its tanks of sulfuric acid.

Standard Resin Systems Available*

| Resin Code | Description | Resin Base | Corrosion Resistance | Flame Spread Rating** | NSF-61 Certified |
|------------|------------------------------------|---------------|----------------------|-----------------------|------------------|
| VE | Chemical Proof Fire Retardant | Vinyl Ester | Excellent | Class 1 25 or less | |
| NVE | Chemical Proof Fire Retardant | Vinyl Ester | Excellent | Class 1 25 or less | Hot & Cold |
| XVE | Chemical Proof Fire Retardant | Vinyl Ester | Excellent | Class 1 10 or less | |
| PP | Industrial Grade Fire Retardant | Isophthalic | Very Good | Class 1 25 or less | |
| NPP | Industrial Grade Fire Retardant | Isophthalic | Very Good | Class 1 25 or less | Hot & Cold |
| GP | Architectural Grade Fire Retardant | Orthophthalic | Good | Class 1 25 or less | |
| FF | Food Grade Fire Retardant | Isophthalic | Very Good | Class 2 30 or less | |

*Strongwell's standard colors are dark gray, green, yellow, orange and light gray. Contact Customer Service for resin system and color requirements. Custom colors are available upon request.

** Flame Spread Rating per ASTM E-84 Tunnel Test



Technical Data

Shapes, Sizes and Availability

| Typical DURAGRATE® Panels | | |
|---------------------------|-------------------------|---------------------------------------|
| THICKNESS | MESH PATTERN | PANEL SIZES |
| 1" | 1-1/2" Square | 3' x 10', 4' x 8', 4' x 12' |
| 1" | 1" x 4" Rectangular | 3' x 10', 4' x 12' |
| 1-1/2" | 3/4" x 3/4" Mini-Grid™ | 4' x 12' |
| 1-1/2" | 1-1/2" x 6" Rectangular | 4' x 12' |
| 1-1/2" | 1-1/2" Square | 3' x 10', 4' x 8', 4' x 12', 5' x 10' |
| 2" | 2" Square | 4' x 12' |

NOTE: All panel sizes available in VE, XVE, PP, GP or FF resin systems. NPP and NVE resin systems are available in most panel sizes. Custom panel sizes and resins available upon request. Descriptions of the different resin systems are located on the previous page.

How to Specify

The molded fiberglass grating shall be DURAGRATE® as supplied by Strongwell. Grating panels shall be (pick one from chart for thickness, mesh pattern, resin code) molded grid pattern. The grating shall be one-piece construction with the tops of the bearing bars and cross bars in the same plane. Color choices are green, orange, yellow, dark gray, light gray. Surface shall be concave top or gritted.

Stair Treads

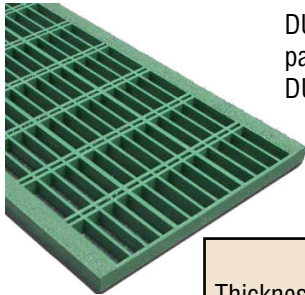

DURAGRATE® molded fiberglass stair treads are available in a 1-1/2" thick 1-1/2" x 6" rectangular mesh pattern. The standard panel size is 22-1/2" x 10'. Stair treads can be produced in any of the standard DURAGRATE® resin systems. The stair tread panel comes complete with anti-slip nosing.

DURAGRATE® Stair Tread

| Thickness | Mesh | Panel Size | Maximum Span for 300 lbs. at Mid-Span | | Panel Weight | Open Area |
|-----------|-------------|---------------|---------------------------------------|-------------------------|--------------|-----------|
| | | | 1/8" or less deflection | 1/4" or less deflection | | |
| 1-1/2" | 1-1/2" x 6" | 22-1/2" x 10' | 31" | 38" | 60 lbs. | 67% |

Stair Tread Panel Cutting Diagram

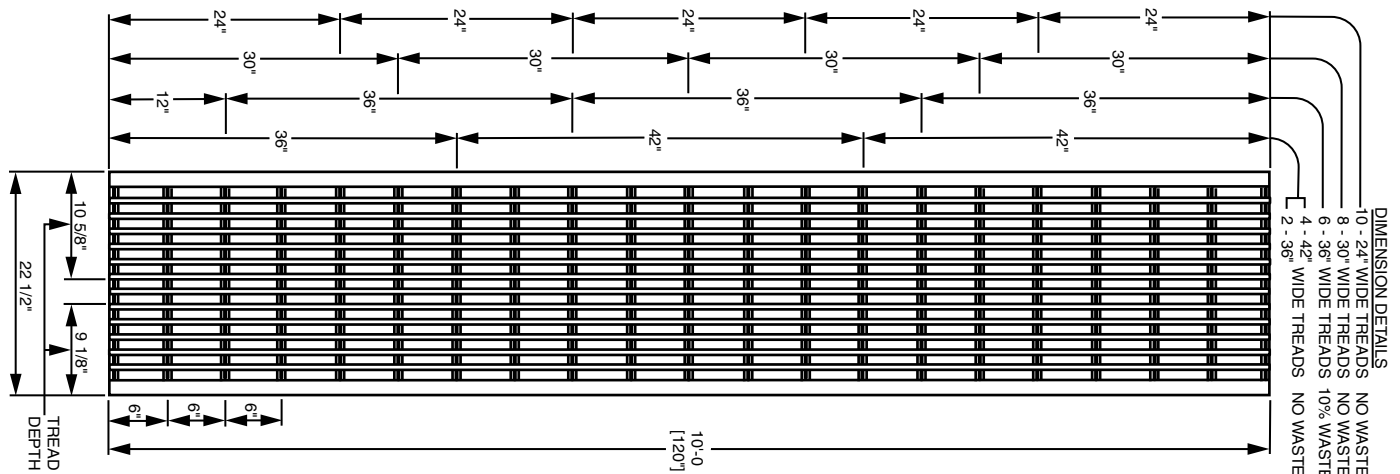

Accessories

Panel Installation

Type M Clips

For attaching grating to supports.

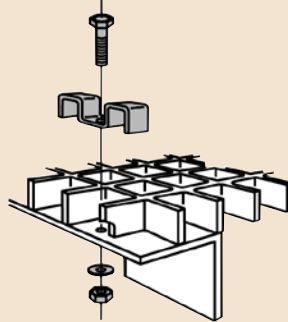

Type J Clips

For attaching grating to supports for moderate loads.

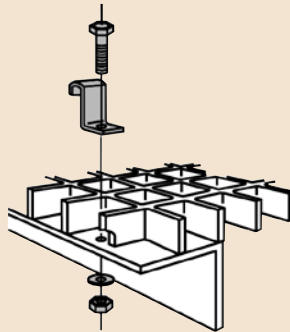

Type C Clips

For joining two unsupported edges if needed.

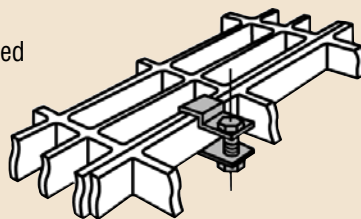

Sealing Kits

To maintain corrosion resistance and structural integrity, standard resin sealing kits are available to protect the exposed ends of cut panels and other components.

Solid Surface

DURAGRATE® is available with an integral cover bonded to the top surface with a slip resistant grit surface.



Elevated Floor System

Fixed and adjustable legs for molded grating are available to provide sturdy support for elevated flooring. Contact Strongwell with your exact requirements.

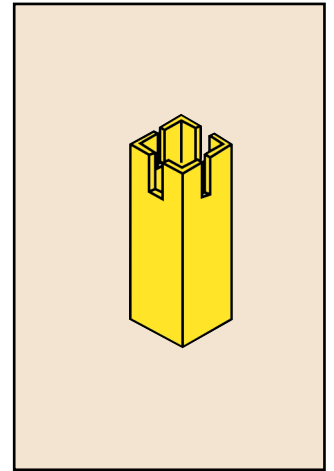
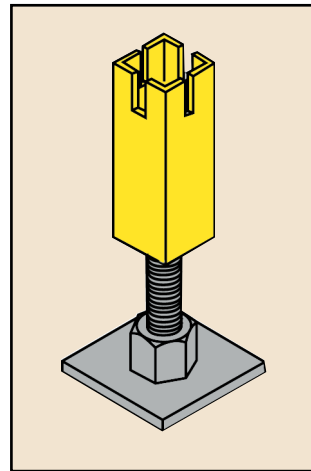

Curb Angle

Strongwell's pultruded fiberglass Curb Angle provides a strong, firm base for bearing bars. Standard Curb Angle is produced using a gray, fire retardant vinyl ester resin system and is available in three sizes.

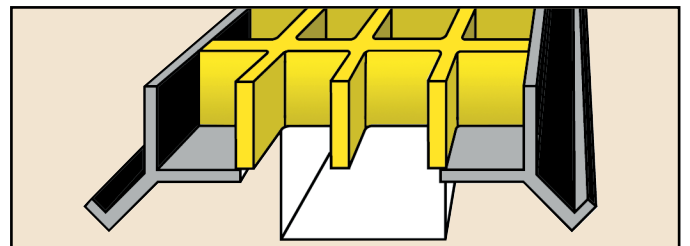

Load Tables

1" THICK 1-1/2" SQUARE MESH DURAGRATE®

A=1.71 in.²/ft. of width
 l=0.14 in.⁴/ft. of width
 S=0.29 in.³/ft. of width

1" bearing bars: Values per foot of width
 Open Space = 70%
 Approx. Weight = 2.6 lbs/sq. ft.

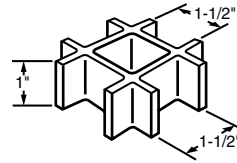

| SPAN INCHES | | LOAD | | | | | | | | SAFE LOAD 5:1 SAFETY FACTOR | DEFLECTION | E x 10 ⁶ PSI |
|-------------|----|--------|--------|-------|-------|-------|-------|-------|-------|-----------------------------------|------------|----------------------------|
| | | 50 | 100 | 150 | 200 | 250 | 300 | 400 | 500 | | | |
| 12 | Δu | <0.010 | <0.010 | 0.013 | 0.017 | 0.021 | 0.025 | 0.034 | 0.042 | 1360 | 0.115 | 1.90 |
| | Δc | <0.010 | 0.014 | 0.020 | 0.027 | 0.034 | 0.041 | 0.054 | 0.068 | 680 | 0.092 | |
| 18 | Δu | 0.021 | 0.041 | 0.062 | 0.082 | 0.103 | 0.123 | 0.164 | 0.205 | 666 | 0.274 | 1.98 |
| | Δc | 0.022 | 0.044 | 0.066 | 0.088 | 0.110 | 0.131 | 0.175 | 0.219 | 500 | 0.219 | |
| 24 | Δu | 0.064 | 0.128 | 0.192 | 0.256 | 0.320 | 0.384 | 0.512 | 0.640 | 380 | 0.486 | 2.01 |
| | Δc | 0.051 | 0.102 | 0.154 | 0.205 | 0.256 | 0.307 | 0.409 | 0.512 | 380 | 0.389 | |
| 30 | Δu | 0.155 | 0.309 | 0.464 | 0.619 | | | | | 240 | 0.742 | 2.03 |
| | Δc | 0.099 | 0.198 | 0.297 | 0.396 | 0.495 | 0.594 | | | 300 | 0.594 | |
| 36 | Δu | 0.318 | 0.635 | | | | | | | 160 | 1.016 | 2.05 |
| | Δc | 0.169 | 0.339 | 0.508 | 0.677 | | | | | 240 | 0.813 | |

1" THICK 1" x 4" RECTANGULAR MESH DURAGRATE®

A=2.57 in.²/ft. of width
 l=0.22 in.⁴/ft. of width
 S=0.43 in.³/ft. of width

1" bearing bars: Values per foot of width
 Open Space = 69%
 Approx. Weight = 2.8 lbs/sq. ft.

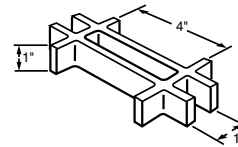

| SPAN INCHES | | LOAD | | | | | | | | SAFE LOAD 5:1 SAFETY FACTOR | DEFLECTION | E x 10 ⁶ PSI |
|-------------|----|--------|--------|--------|-------|-------|-------|-------|-------|-----------------------------------|------------|----------------------------|
| | | 50 | 100 | 150 | 200 | 250 | 300 | 400 | 500 | | | |
| 12 | Δu | <0.010 | <0.010 | <0.010 | 0.011 | 0.014 | 0.017 | 0.022 | 0.028 | 1960 | 0.108 | 1.85 |
| | Δc | <0.010 | <0.010 | 0.013 | 0.018 | 0.022 | 0.027 | 0.035 | 0.044 | 980 | 0.087 | |
| 18 | Δu | 0.012 | 0.025 | 0.037 | 0.049 | 0.062 | 0.074 | 0.099 | 0.123 | 960 | 0.237 | 2.10 |
| | Δc | 0.013 | 0.026 | 0.039 | 0.053 | 0.066 | 0.079 | 0.105 | 0.131 | 720 | 0.189 | |
| 24 | Δu | 0.037 | 0.074 | 0.112 | 0.149 | 0.186 | 0.223 | 0.298 | 0.372 | 560 | 0.417 | 2.20 |
| | Δc | 0.030 | 0.060 | 0.089 | 0.119 | 0.149 | 0.179 | 0.238 | 0.298 | 560 | 0.333 | |
| 30 | Δu | 0.088 | 0.176 | 0.264 | 0.352 | 0.440 | 0.528 | | | 336 | 0.591 | 2.27 |
| | Δc | 0.056 | 0.113 | 0.169 | 0.225 | 0.282 | 0.338 | 0.451 | 0.563 | 420 | 0.473 | |
| 36 | Δu | 0.176 | 0.353 | 0.529 | | | | | | 240 | 0.846 | 2.35 |
| | Δc | 0.094 | 0.188 | 0.282 | 0.376 | 0.470 | 0.564 | | | 360 | 0.677 | |
| 42 | Δu | 0.316 | 0.632 | | | | | | | 183 | 1.155 | 2.43 |
| | Δc | 0.144 | 0.289 | 0.433 | 0.577 | | | | | 320 | 0.924 | |

NOTE: Rectangular grating tables are for loading in the crosswise orientation.

- c IS CONCENTRATED LOAD LBS/FT OF WIDTH
- Δc IS DEFLECTION UNDER CONCENTRATED LOAD(in)
- u IS UNIFORM LOAD LBS/FT²
- Δu IS DEFLECTION UNDER UNIFORM LOAD(in)

NOTE: ALL TABLE VALUES ARE TYPICAL

Uniform Load

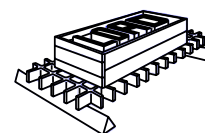

Concentrated Load

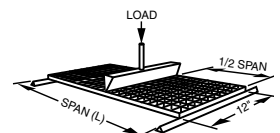

Load Tables

1-1/2" THICK 1-1/2" SQUARE MESH DURAGRATE®

A=2.85 in.²/ft. of width
 l=0.51 in.⁴/ft. of width
 S=0.65 in.³/ft. of width

1-1/2" bearing bars: Values per foot of width
 Open Space = 70%
 Approx. Weight = 3.8 lbs/sq.ft.

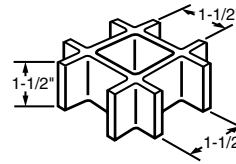

| SPAN INCHES | | LOAD | | | | | | | | SAFE LOAD 5:1 SAFETY FACTOR | DEFLECTION | E x 10 ⁶ PSI |
|----------------|----|--------|--------|--------|--------|--------|-------|-------|-------|-----------------------------------|------------|----------------------------|
| | | 50 | 100 | 150 | 200 | 250 | 300 | 400 | 500 | | | |
| 12 | Δu | <0.010 | <0.010 | <0.010 | <0.010 | <0.010 | 0.011 | 0.014 | 0.018 | 3120 | 0.111 | 1.24 |
| | Δc | <0.010 | <0.010 | <0.010 | 0.011 | 0.014 | 0.017 | 0.023 | 0.028 | 1560 | 0.089 | |
| 18 | Δu | <0.010 | 0.014 | 0.021 | 0.028 | 0.036 | 0.043 | 0.057 | 0.071 | 1386 | 0.197 | 1.57 |
| | Δc | <0.010 | 0.015 | 0.023 | 0.030 | 0.038 | 0.046 | 0.061 | 0.076 | 1040 | 0.158 | |
| 24 | Δu | 0.021 | 0.042 | 0.063 | 0.084 | 0.104 | 0.125 | 0.167 | 0.209 | 780 | 0.326 | 1.69 |
| | Δc | 0.017 | 0.033 | 0.050 | 0.067 | 0.084 | 0.100 | 0.134 | 0.167 | 780 | 0.261 | |
| 30 | Δu | 0.047 | 0.094 | 0.141 | 0.188 | 0.235 | 0.283 | 0.377 | 0.471 | 496 | 0.467 | 1.83 |
| | Δc | 0.030 | 0.060 | 0.090 | 0.121 | 0.151 | 0.181 | 0.241 | 0.301 | 620 | 0.374 | |
| 36 | Δu | 0.096 | 0.192 | 0.288 | 0.384 | 0.480 | 0.576 | | | 347 | 0.666 | 1.86 |
| | Δc | 0.051 | 0.102 | 0.154 | 0.205 | 0.256 | 0.307 | 0.410 | 0.512 | 520 | 0.533 | |
| 42 | Δu | 0.175 | 0.350 | 0.525 | | | | | | 251 | 0.881 | 1.89 |
| | Δc | 0.080 | 0.160 | 0.240 | 0.320 | 0.400 | 0.480 | 0.641 | 0.801 | 440 | 0.705 | |
| 48 | Δu | 0.287 | 0.573 | | | | | | | 170 | 0.975 | 1.97 |
| | Δc | 0.115 | 0.229 | 0.344 | 0.459 | 0.573 | 0.688 | | | 340 | 0.780 | |

1-1/2" THICK 3/4" MINI-GRID™ DURAGRATE®

A=3.62 in.²/ft. of width
 l=0.73 in.⁴/ft. of width
 S=0.90 in.³/ft. of width

1-1/2" bearing bars: Values per foot of width
 Open Space = 44%
 Approx. Weight = 4.4 lbs/sq.ft.

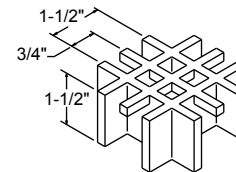

| SPAN INCHES | | LOAD | | | | | | | | SAFE LOAD 5:1 SAFETY FACTOR | DEFLECTION | E x 10 ⁶ PSI |
|----------------|----|--------|--------|-------|-------|-------|-------|-------|-------|-----------------------------------|------------|----------------------------|
| | | 50 | 100 | 150 | 200 | 250 | 300 | 400 | 500 | | | |
| 12 | Δu | <0.010 | <0.010 | 0.011 | 0.014 | 0.017 | 0.021 | 0.028 | 0.035 | 3860 | 0.270 | 0.44 |
| | Δc | <0.010 | 0.011 | 0.017 | 0.022 | 0.028 | 0.034 | 0.045 | 0.056 | 1930 | 0.216 | |
| 18 | Δu | 0.013 | 0.026 | 0.039 | 0.052 | 0.065 | 0.078 | 0.104 | 0.130 | 1776 | 0.470 | 0.59 |
| | Δc | 0.014 | 0.028 | 0.042 | 0.056 | 0.070 | 0.084 | 0.112 | 0.139 | 1332 | 0.376 | |
| 24 | Δu | 0.025 | 0.050 | 0.075 | 0.100 | 0.126 | 0.151 | 0.201 | 0.251 | 1052 | 0.529 | 0.98 |
| | Δc | 0.020 | 0.040 | 0.060 | 0.080 | 0.101 | 0.121 | 0.161 | 0.201 | 1052 | 0.423 | |
| 30 | Δu | 0.055 | 0.110 | 0.165 | 0.219 | 0.274 | 0.329 | 0.439 | 0.548 | 632 | 0.692 | 1.10 |
| | Δc | 0.035 | 0.070 | 0.105 | 0.140 | 0.176 | 0.211 | 0.281 | 0.351 | 790 | 0.553 | |
| 36 | Δu | 0.087 | 0.173 | 0.260 | 0.346 | 0.433 | 0.520 | 0.692 | | 456 | 0.796 | 1.43 |
| | Δc | 0.046 | 0.092 | 0.139 | 0.185 | 0.231 | 0.277 | 0.370 | 0.462 | 684 | 0.637 | |
| 42 | Δu | 0.150 | 0.300 | 0.450 | 0.600 | | | | | 332 | 1.005 | 1.53 |
| | Δc | 0.069 | 0.138 | 0.207 | 0.276 | | | | | 582 | 0.804 | |
| 48 | Δu | 0.245 | 0.490 | 0.735 | | | | | | 215 | 1.054 | 1.61 |
| | Δc | 0.098 | 0.196 | 0.294 | | | | | | 430 | 0.843 | |

Load Tables

2" THICK 2" SQUARE MESH DURAGRATE®

A=2.88 in.²/ft. of width
 I=0.96 in.⁴/ft. of width
 S=0.94 in.³/ft. of width

2" bearing bars: Values per foot of width
 Open Space = 72%
 Approx. Weight = 4.0 lbs/sq.ft.

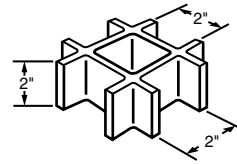

| SPAN INCHES | | LOAD | | | | | | | | SAFE LOAD 5:1 SAFETY FACTOR | DEFLECTION | E x 10 ⁶ PSI |
|-------------|----|--------|--------|--------|--------|--------|--------|--------|-------|-----------------------------------|------------|----------------------------|
| | | 50 | 100 | 150 | 200 | 250 | 300 | 400 | 500 | | | |
| 12 | Δu | <0.010 | <0.010 | <0.010 | <0.010 | <0.010 | <0.010 | <0.010 | 0.010 | 4000 | 0.081 | 1.15 |
| | Δc | <0.010 | <0.010 | <0.010 | <0.010 | <0.010 | 0.010 | 0.013 | 0.016 | 2000 | 0.065 | |
| 18 | Δu | <0.010 | <0.010 | 0.012 | 0.016 | 0.020 | 0.024 | 0.032 | 0.040 | 1813 | 0.145 | 1.48 |
| | Δc | <0.010 | <0.010 | 0.013 | 0.017 | 0.021 | 0.026 | 0.034 | 0.043 | 1360 | 0.116 | |
| 24 | Δu | 0.010 | 0.021 | 0.031 | 0.042 | 0.052 | 0.063 | 0.083 | 0.104 | 960 | 0.200 | 1.80 |
| | Δc | <0.010 | 0.017 | 0.025 | 0.033 | 0.042 | 0.050 | 0.067 | 0.083 | 960 | 0.160 | |
| 30 | Δu | 0.023 | 0.046 | 0.069 | 0.092 | 0.114 | 0.137 | 0.183 | 0.229 | 640 | 0.293 | 2.00 |
| | Δc | 0.015 | 0.029 | 0.044 | 0.059 | 0.073 | 0.088 | 0.117 | 0.146 | 800 | 0.234 | |
| 36 | Δu | 0.044 | 0.089 | 0.133 | 0.177 | 0.222 | 0.266 | 0.355 | 0.444 | 453 | 0.402 | 2.14 |
| | Δc | 0.024 | 0.047 | 0.071 | 0.095 | 0.118 | 0.142 | 0.189 | 0.237 | 680 | 0.322 | |
| 42 | Δu | 0.082 | 0.164 | 0.245 | 0.327 | 0.409 | 0.491 | 0.654 | | 331 | 0.542 | 2.15 |
| | Δc | 0.037 | 0.075 | 0.112 | 0.150 | 0.187 | 0.224 | 0.299 | 0.374 | 580 | 0.434 | |
| 48 | Δu | 0.135 | 0.270 | 0.405 | 0.541 | | | | | 260 | 0.703 | 2.22 |
| | Δc | 0.054 | 0.108 | 0.162 | 0.216 | 0.270 | 0.324 | 0.432 | 0.541 | 520 | 0.562 | |
| 54 | Δu | 0.210 | 0.420 | 0.630 | | | | | | 204 | 0.858 | 2.29 |
| | Δc | 0.075 | 0.149 | 0.224 | 0.298 | 0.373 | 0.448 | 0.597 | | 460 | 0.686 | |

1-1/2" THICK 1-1/2" x 6" RECTANGULAR DURAGRATE®

A=3.785 in.²/ft. of width
 I=0.56 in.⁴/ft. of width
 S=1.500 in.³/ft. of width

1-1/2" bearing bars: Values per foot of width
 Open Space = 67%
 Approx. Weight = 3.5 lbs/sq.ft.

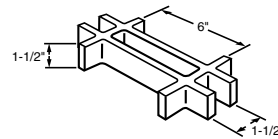

| SPAN INCHES | | LOAD | | | | | | | | SAFE LOAD 5:1 SAFETY FACTOR | DEFLECTION | E x 10 ⁶ PSI |
|-------------|----|--------|--------|--------|--------|-------|-------|-------|-------|-----------------------------------|------------|----------------------------|
| | | 50 | 100 | 150 | 200 | 250 | 300 | 400 | 500 | | | |
| 12 | Δu | <0.010 | <0.010 | <0.010 | <0.010 | 0.011 | 0.014 | 0.018 | 0.023 | 4272 | 0.195 | 0.88 |
| | Δc | <0.010 | <0.010 | 0.011 | 0.015 | 0.018 | 0.022 | 0.029 | 0.037 | 2136 | 0.156 | |
| 18 | Δu | <0.010 | 0.018 | 0.027 | 0.035 | 0.044 | 0.053 | 0.071 | 0.089 | 1712 | 0.300 | 1.16 |
| | Δc | 0.010 | 0.019 | 0.028 | 0.038 | 0.047 | 0.057 | 0.076 | 0.095 | 1284 | 0.240 | |
| 24 | Δu | 0.019 | 0.038 | 0.056 | 0.075 | 0.094 | 0.112 | 0.150 | 0.188 | 956 | 0.359 | 1.71 |
| | Δc | 0.015 | 0.030 | 0.045 | 0.060 | 0.075 | 0.090 | 0.120 | 0.150 | 956 | 0.288 | |
| 30 | Δu | 0.039 | 0.078 | 0.117 | 0.156 | 0.195 | 0.233 | 0.311 | 0.389 | 587 | 0.458 | 2.01 |
| | Δc | 0.025 | 0.050 | 0.075 | 0.100 | 0.125 | 0.150 | 0.200 | 0.250 | 734 | 0.367 | |
| 36 | Δu | 0.071 | 0.143 | 0.214 | 0.285 | 0.357 | 0.428 | | | 385 | 0.550 | 2.28 |
| | Δc | 0.038 | 0.076 | 0.114 | 0.152 | 0.190 | 0.228 | 0.304 | 0.381 | 578 | 0.440 | |
| 42 | Δu | 0.126 | 0.252 | 0.378 | 0.504 | 0.630 | | | | 370 | 0.680 | 2.39 |
| | Δc | 0.058 | 0.115 | 0.173 | 0.230 | 0.288 | 0.346 | 0.461 | | 472 | 0.544 | |
| 48 | Δu | 0.207 | 0.414 | 0.621 | | | | | | 184 | 0.760 | 2.49 |
| | Δc | 0.083 | 0.160 | 0.248 | 0.331 | 0.414 | 0.497 | | | 368 | 0.608 | |



Alro *Plastics*

Your Source for Engineering Plastics

Alro Plastics is an industry leader in supplying engineering plastic shapes and parts. We cut and/or ship the same day your order is placed and provide value added processing to meet the most demanding fabrication requirements.

PRODUCTS

| | | | |
|----------------------|---------------------|-----------------|-------------------|
| ABS | EXTRUSIONS | NYLATRON® GSM | RADEL® |
| ACETAL | FGI-AM™ GRATING | NYLATRON® NSM | REPROCESSED UHMW |
| ACETRON® GP | FIBERGLASS | NYLOIL® | RUBBER |
| ACRYLIC | FILMS | NYLONS | SAFPLATE® |
| ANTI-MICROBIAL | FLUOROSINT® | NYMETAL™ | SAFRAIL™ |
| BALLISTIC PROTECTION | G10 / FR-4 | OPTIX® | SANALITE® |
| BORATED PE | GPO-3 | PALIGHT® | SEMITRON® |
| CAST NYLON | HDPE | PALSUN® | STARBOARD® |
| CELAZOLE® | HYDEX® 202/301 | PBT | SUSTARIN® C |
| CHEMGRATE® | HYDEX® 4101/4101L | PEEK | TECAFORM® HPV 13 |
| CLEAR PVC | HYDLAR® Z | PET | TECAFORM® UD BLUE |
| COLORCORE® | HY-PACT® VH | PETG | TECHTRON® |
| COMPOSOLITE® | IND. LAMINATES | PHENOLIC | TIVAR® |
| CPVC | KETRON® PEEK | PLEXIGLAS® | TIVAR® 1000 |
| CUTTING BOARD | KOMA ALU® | POLYCARBONATE | TIVAR® 88 |
| DELRIN® | KOMATEX® | POLYETHYLENE | TIVAR® H.O.T. |
| DELRIN® AF | KYDEX® | POLYPROPYLENE | TOOLING BOARD |
| DENSETEC® | KYNAR® PVDF | POLYSTONE® M | TORLON® |
| DURADEK® | LDPE | POLYSULFONE | UHMW-PE |
| DURAGRATE® | LIFE SCIENCE GRADES | PPS | ULTEM® |
| DURAGRID® | LubX® C | PRECISION BOARD | URETHANE |
| DURAPLEX® | MAKROLON® | PROFILES | USDA GRATING |
| DURASHIELD® | MC® 901/907 | PROPYLUX® | VHMW SHEET |
| DURATREAD® | MEDICAL GRADES | PTFE / TFE | VIVAK® |
| DURATRON® | MICARTA® | PVC | WALLTUF® |
| ERTALYTE® | MIRROR | PVC FOAM SHEET | WEARGEHR® |
| EXTREN® | NORYL® PPO | PVDF | ZELUX® |

Many products available in sheet, rod, tube and custom shapes. Call for inquiry.



Alro *Plastics*

LIVONIA

34401 Schoolcraft Rd
Livonia, MI 48150
Fax: (517) 787-6380
Toll Free: (800) 877-2576

JACKSON

2218 Enterprise
Jackson, MI 49204
Local: (517) 787-5500
Fax: (517) 787-6380
Toll Free: (800) 877-2576

GRAND RAPIDS

4150 Broadmoor SE
Grand Rapids, MI 49512
Local: (616) 656-2820
Fax: (616) 656-2828
Toll Free: (888) 877-2576

LOUISVILLE

5620 Shepherdsville Rd
Louisville, KY 40228
Local: (502) 968-9980
Fax: (502) 968-5530
Toll Free: (877) 968-9980

CLEARWATER

10585 47th Street N.
Clearwater, FL 33762
Local: (727) 573-1480
Fax: (727) 573-1632

alroplastics.com

ST0614

800-877-ALRO

2 5 7 6